

Republic of the Philippines
ENERGY REGULATORY COMMISSION
San Miguel Avenue, Pasig City

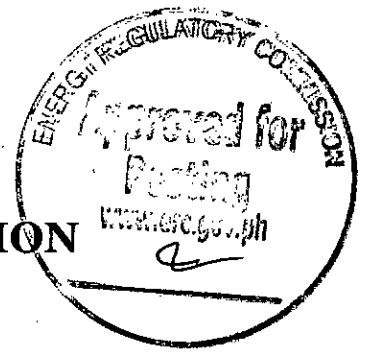

IN THE MATTER OF THE APPLICATION FOR AUTHORITY TO DEVELOP AND OWN OR OPERATE DEDICATED POINT-TO-POINT LIMITED FACILITIES TO CONNECT THE 5 MW SPARC ZAMBALES PROJECT TO THE DISTRIBUTION SYSTEM OF ZAMBALES I ELECTRIC COOPERATIVE, INC. (ZAMECO I) AT THE SALAZA 5 MVA SUBSTATION, WITH PRAYER FOR PROVISIONAL AUTHORITY

ERC CASE NO. 2015-078 MC

**SPARC-SOLAR POWERED AGRI-RURAL COMMUNITIES CORPORATION (SPARC),
Applicant.**

X-----X

DOCKETED
Date: **FEB 22 2016**
By: _____

ORDER

On 11 November 2015, Solar Powered Agri-Rural Communities Corporation (SPARC) filed an application for authority to develop, own, and operate dedicated point-to-point limited facilities to connect the 5 MW SPARC Zambales Project to the distribution system of Zambales I Electric Cooperative, Inc. (ZAMECO I), located at the SALAZA 5 MVA Substation, with prayer for the issuance of provisional authority.

In support of said application, SPARC alleged, among others, the following:

1. That Applicant SPARC is a corporation duly organized and existing under and by virtue of Philippine laws, with principal office at Bonifacio Technology Center, 2nd Avenue corner 31st Street, Bonifacio Global City, Taguig City, Metro Manila. It may

be served with pleadings, notices, orders and other legal processes through the undersigned Firm;

2. SPARC is engaged in the business of generating power derived from solar energy and other viable sources of renewable energy for lighting and power purposes. Copies of relevant corporate documents of SPARC were attached as integral parts of its application, as follows:

ANNEX	DOCUMENT
"A"	Certificate of Incorporation
"B"	Articles of Incorporation and By-Laws
"C"	General Information Sheet for Year 2015
"D"	Certificate of Non-Coverage from the Department of Environment and Natural Resources (DENR)
"E"	Audited Financial Statements for 2014
"F"	Renewable Energy Developer Certificate of Registration issued by the Department of Energy (DOE)

3. As a registered Renewable Energy (RE) Developer, SPARC was granted a Solar Energy Service Contract (SESC) to construct, operate, and maintain a 5 MW solar farm facility on properties owned by the Agrarian Reform Beneficiaries (ARBs) in Agrarian Reform Communities (ARC) located at Barangay Bulawen/Salaza, Palauig, Zambales (hereinafter, the "5 MW SPARC Zambales Project");
4. SPARC intends to sell all power generated from its 5 MW PV power plant under the Feed-in Tariff (FIT) System at a rate of PHP 8.69/kWh¹;
5. All output of the power plant will be delivered and sold through the primary distribution system of Zambales I Electric Cooperative, Inc. (ZAMECO I) at the Salaza 5 MVA, 69-13.8 kV substation via a line approximately four (4) kilometers in length;
6. The figure below shows the single line diagram of the 5MW SPARC Zambales Project connected to the Salaza substation 13.8 kV bus:

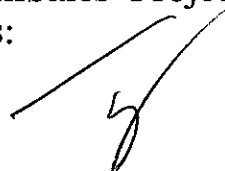

¹ ERC Resolution No. 06, Series of 2015

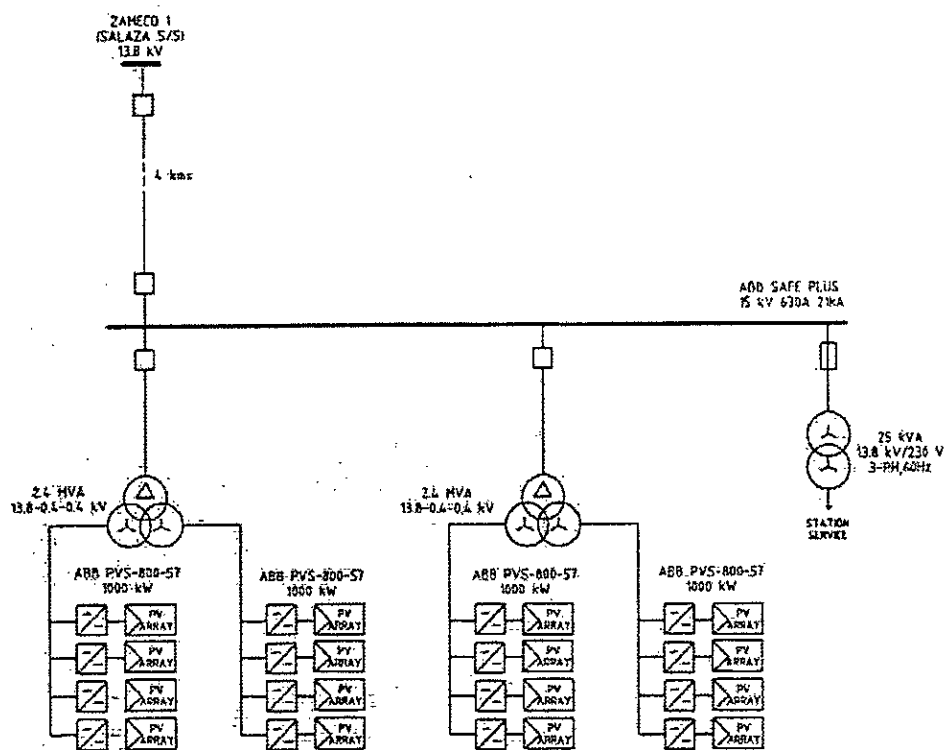

7. The 5 MW SPARC Zambales Project is small in size and can connect to low voltage lines. Thus, SPARC decided that embedding to ZAMECO I's distribution system through herein proposed interconnection facilities is more economical than connecting to the high voltage lines of the Luzon Grid;
8. The foregoing proposed dedicated point-to-point limited facilities are required only for the purpose of connecting the 5 MW SPARC Zambales Project to ZAMECO I's distribution system, and shall be used solely by SPARC;
9. To obtain the Commission's authority to develop, own, and operate the proposed dedicated point-to-point limited facilities, SPARC filed its Application pursuant to Section 2.9.2 (Connection Assets and Facilities) of the 2010 Distribution Services and Open Access Rules, as amended (DSOAR), which provides that:

A generation company may develop and own or operate dedicated point-to-point limited facilities provided, that such facilities are required only for the purpose of connecting to the distribution system, and are used solely by the generating facility, subject to prior authorization by the ERC.

10. A Distribution Impact Study (DIS) was performed by ATEA Inc., a licensed holder of the PSS®E software used to perform load flow and short-circuit simulations, to confirm the feasibility of connecting the 5 MW SPARC Zambales Project to ZAMECO I's 13.8kV primary distribution system. A copy of the DIS is attached as Annex "G" of the application;
11. The entry of the 5 MW SPARC Zambales Project into the distribution system of ZAMECO I is technically feasible based on the following findings in the DIS:
 - a. The presence of the plant in Salaza, Palauig, Zambales, relieves the loading of the existing 5 MVA 69-13.9 kV power transformer;
 - b. The voltage level improves in the proximate areas; and
 - c. The short-circuit contribution of the PV plant is small compared to the short-circuit current injected by the Grid.
12. For the procurement of materials and labor costs for the installation of the proposed dedicated point-to-point limited facilities, which shall utilize, among others, ACSR #2 and #4/0 AWG 6/1 bare conductors, sixty four (64) pieces of 40' concrete poles, eighteen (18) pieces of 40' steel poles, #4 AWF aluminum alloy tie wires, 3 strand 5/16" diameter galvanized grounding wires, 3/8" 7 strand steel guy wires, and 330A 15V load break switch, SPARC shall engage the services of FBF Industrial Sales and Services for a total contract amount of PhP6,460,906.50. A breakdown of the project cost is shown in Annex "H" of the application;
13. When completed, ZAMECO I shall operate and maintain the proposed dedicated point-to-point limited facilities in a non-discriminatory manner, such that the availability thereof shall be at the same service level as the distribution system. A Connection Agreement is still being negotiated between ZAMECO I and SPARC;
14. In support of the Application, the following documents are also being submitted to the Commission:

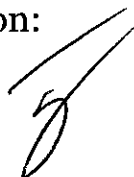

ANNEX	DOCUMENT
"I"	Vicinity Map of the 5 MW SPARC Zambales Project
"J"	Single line diagram of the 5 MW SPARC Zambales Project
"K"	Gantt Chart/Work Schedule for the proposed dedicated point-to-point limited facilities
"L"	Sensitivity Analysis showing Expected Internal Rate of Return
"M"	Secretary's Certificate attesting to the resolution of SPARC's Board of Directors authorizing the development and ownership or operation of the proposed dedicated point-to-point limited facilities; the filing of an application with the Commission for authority to undertake the same; designating a representative to said application; and engaging the services of Diccion Law Firm therefor

15. SPARC reserves the right to submit additional documents as may be required by exigencies or when so ordered by the Commission.

16. SPARC will sell 100% of the power generated by its 5MW SPARC Zambales Project under the FIT System. Pursuant to *Resolution No.6, Series of 2015*, a solar FIT rate equivalent to PhP8.69/kWh applicable for the second batch of solar power projects, shall be implemented for new capacities that will be covered by the revised 500 MW installation target, which is valid upon full subscription thereof or until 15 March 2016, whichever comes first²;

17. SPARC is currently in the process of securing permits and undertaking all required activities to be among the FIT-eligible

² DOE Certification dated 30 April 2014

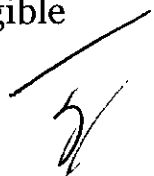

second batch of solar power projects that can avail of the PhP8.69/kWh FIT;

18. Among the requirements to be nominated eligible for the second round of solar FIT is the DOE's confirmation of SPARC's Electromechanical Completion. Under the DOE's *Department Circular No. 2013-05-0009* governing the selection of RE projects under FIT System and the award of Certificate for FIT Eligibility, the DOE shall issue the confirmation or denial of Electromechanical Completion, including the existence of interconnection facility³. It is provided thereunder that:

“Section 6. Issuance of Certificate of Endorsement for FIT Eligibility.

- a. *The RE Developer shall inform the DOE that it has attained the Electromechanical Completion of the project to which the latter shall, within fifteen (15) working days from receipt thereof, conduct a site validation and inspection of the project **including the interconnection facility.***
- b. *Electromechanical Completion is deemed attained if the construction phase is at least eighty percent (80%) completed as may be determined from the RE Developer's Engineering, Procurement and Construction (EPC) contract or construction and development timeline under the approved Work Plan.*
- c. *Not later than fifteen (15) working days from the last day of site validation, the DOE shall issue the confirmation or denial of the Electromechanical Completion, **including the existence of interconnection facility.***
- d. *In the event the DOE confirms Electromechanical Completion of the project, it shall, within a period of five (5) days from the issuance thereof, nominate the eligibility of the project under the FIT system to the Energy Regulatory Commission (ERC) for the processing of Certificate of Compliance (COC) under FIT System, provided that the interconnection facility is fully in place. The DOE nomination to the ERC shall not be constructed as*

³ Section 6. Issuance of Certificate of Endorsement for FIT Eligibility

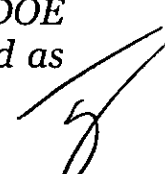

giving right to the RE Developer to be included in the FIT eligible projects.” [Emphasis supplied.]

19. Strictly applying the foregoing dates, SPARC should notify the DOE that it has attained Electromechanical Completion, including the existence of interconnection facility, not later than 25 January 2016, approximately, excluding the period of processing with the Commission of a COC under the FIT System. Meanwhile, per its Work Schedule, SPARC undertakes to complete 80% of the construction phase by, more or less, 22 January 2016, when its Electromechanical Completion shall be deemed attained;
20. Thus, prior thereto, it must have already secured authority from the Commission, albeit provisionally, to develop and own or operate the proposed dedicated point to point limited facilities, and actually construct the same, so it can timely declare Electromechanical Completion;
21. The 5 MW SPARC Zambales Project must, therefore, be immediately connected to the distribution system of ZAMECO I for it to be included within the 500 MW installation target approved for solar energy technology, thereby qualifying it for the second wave of FIT;
22. Pending hearing on the merits, and considering the urgency of beating the foregoing 15 March 2016 deadline, a provisional authority to develop and own or operate the proposed dedicated point-to-point limited facilities to connect the 5 MW SPARC Zambales Project to ZAMECO I's distribution system at the Salaza 5 MVA, 69-13.8 kV substation is herein prayed for;
23. Considering that the subject matter of the Application is akin to the approval by the Commission of electric capital projects. Thus, the relevant provision on the grant of a provisional authority under *ERC Resolution No.13, Series of 2006*, as amended⁴, is hereby invoked. It is provided thereunder:

**“ARTICLE II
APPLICATIONS AND REQUIREMENTS**

2.3 Evaluation and Approval

- xxx -

⁴ Resolution No. 18, series of 2008 and Resolution No. 26, Series of 2009

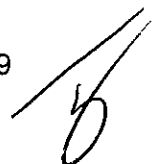

Upon filing of the application, the Commission may, on its own or upon motion, grant the issuance of a Provisional Authority (PA) based on the allegations of the application and on such other documents attached thereto or submitted by the parties. The Commission, if necessary, may schedule a hearing for the issuance of a PA not later than thirty (30) days from the filing of the application. Thereafter, the Commission shall issue a ruling either granting or denying the PA stating clearly the reasons therefore, within seventy five (75) days from the filing of the application.

24. It is imperative for a renewable energy project to be fully connected to the grid or a distribution system and must be able to readily export power thereto to qualify for FIT. Since the installation target for solar energy resource is only at 500 MW, and with the 15 March 2016 deadline, qualifying for FIT is on a *first come, first served* basis among solar energy projects that are fully commissioned and 100% connected to the grid or the distribution system. Therefore, a delay in the approval of the proposed interconnection facilities poses additional risks to SPARC in terms of getting its 5 MW SPARC Zambales Project into the 500MW installation target, that would entitle it to the PhP8.69/kWh FIT rate;
25. Should SPARC fail to qualify for the second wave of solar FIT, but becomes eligible only for the next FIT to be determined by the Commission, there is a possibility that the succeeding FIT rate to be approved for solar energy will be lower. More so, there is no assurance how soon the next solar FIT for the third batch of projects will take effect or be implemented. These uncertainties are perils that SPARC is not willing to take for its 5 MW power plant in Zambales, if it were to ascertain the financial viability of the project;
26. The next available option, then, is for SPARC to deliver power to the Wholesale Electricity Spot Market (WESM). However, this does not put SPARC in a better position considering the unpredictability of market prices, which over the years, proved to be unviable as well. Further, due to its size and the intermittence of its energy source, SPARC will merely be a price-taker in the WESM. As a price-taker, it will have to settle on whatever price the market dictates, even if such price is not enough to recover costs in ensuring the sustainable and viable operation of its solar energy generation plant;

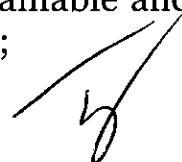

27. Accordingly, as clearly demanded by the foregoing circumstances, a provisional authority for the construction and ownership or operation of the proposed interconnection facilities must be secured to ensure that the 5 MW SPARC Zambales Project qualifies for the second round of solar FIT, safeguarding the viability and sustainability thereof.

28. SPARC prays that prior to and/or pending hearing on the merits, a **PROVISIONAL AUTHORITY** be issued to immediately allow the development and ownership or operation of the proposed dedicated point-to-point limited facilities to connect the 5 MW SPARC Zambales Project to ZAMECO I's distribution system at the Salaza 5 MVA, 69-13.8 kV substation; and that after due notice and hearing, a **FINAL AUTHORITY** be issued to permanently authorize the same. Other reliefs as may be just and equitable under the premises are, likewise, most respectfully prayed for.

Finding the said application to be sufficient in form and in substance with the required fees having been paid, the same is hereby set for determination of compliance with the jurisdictional requirements, expository presentation, pre-trial conference, and presentation of evidence on **11 March 2016 (Friday) at ten o'clock in the morning (10:00 A.M.) at the ERC Hearing Room, 15th Floor, Pacific Center Building, San Miguel Avenue, Pasig City.**

SPARC is hereby directed to cause the publication of the attached Notice of Public Hearing, at its own expense, once (1x) in a newspaper of general circulation in the Philippines, at least ten (10) days before the date of the scheduled initial hearing. It is also directed to inform the consumers, by any other means available and appropriate, of the filing of the instant application, its reasons therefor, and of the scheduled hearing thereon.

Let copies of the application, this Order, and the attached Notice of Public Hearing be furnished the Office of the Solicitor General (OSG), the Commission on Audit (COA), and the Committees on Energy of both Houses of Congress. They are hereby requested, if they so desire, to send their duly authorized representatives at the scheduled hearing.

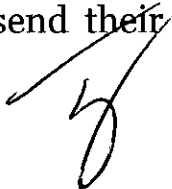

Likewise, let copies of this Order and the attached Notice of Public Hearing be furnished the Offices of the Governor of Zambales and the Mayors of the Municipalities of Palauig, Iba, Taugtog, and Candelaria, Zambales for the appropriate posting thereof on their respective bulletin boards.

SPARC is hereby directed to furnish all those making requests therefor with copies of the application and its attachments, subject to reimbursement of reasonable photocopying costs.

On the date of the initial hearing and pre-trial conference, SPARC must submit to the Commission their written Compliance with the jurisdictional requirements attaching therewith, methodically arranged and duly marked, the evidence of the actual posting and publication of the Notice of Public Hearing consisting of certifications issued to that effect, signed by the afore-mentioned Governors and Mayors or their duly authorized representatives, bearing the seals of their offices, and the affidavits of the Editors or Business Managers of the newspapers where said Notice of Public Hearing were published together with the complete issues of the said newspapers, and such other proofs of compliance with the requirements of the Commission.

SPARC, and all interested parties are directed to submit, at least five (5) days before the date of initial hearing and pre-trial conference, their respective Pre-Trial Briefs containing, among others:

- (a) A summary of admitted facts and proposed stipulation of facts;
- (b) The issues to be tried or resolved;
- (c) The documents or exhibits to be presented, stating the purposes thereof and proposed markings therefore; and
- (d) The number and names of the witnesses, with their written testimonies in an individual affidavit form, to be attached to the Pre-Trial Brief.

Failure of SPARC to submit the required Pre-Trial Brief and Judicial Affidavits of their witnesses within the prescribed period shall be a ground for cancellation of the scheduled hearing, and the resetting of which shall be six (6) months from said date of cancellation.



As part of the pre-trial conference, SPARC must also be prepared to make an expository presentation of their application, aided by whatever communication medium that they may deem appropriate for the purpose, in order to put in plain words and explain, for the benefit of the consumers and other concerned parties, what the application is all about and the reasons and justifications being cited in support thereof.

SO ORDERED.

Pasig City, 10 February 2016.

FOR AND BY AUTHORITY
OF THE COMMISSION:

JOSE VICENTE B. SALAZAR
Chairman and CEO

ERC
Office of the Chairman



B-2016-017-OC-00799

Copy furnished:

- 1. Atty. Mary Ann Castro Diccion-Recto and
Atty. Anna Tricia Paradero Evangelista**
Counsels for Applicant SPARC
Diccion Law Firm
Unit 1912 Jollibee Plaza Building
F. Ortigas Jr. Road, Ortigas Center
Pasig City
- 2. SPARC-Solar Powered Agri-Rural
Communities Corporation (SPARC)**
Bonifacio Technology Center,
2nd Avenue corner 31st Street,
Bonifacio Global City,
Taguig City, Metro Manila
- 3. Office of the Solicitor General**
134 Amorsolo Street, Legaspi Village
Makati City, Metro Manila
- 4. Commission on Audit**
Commonwealth Avenue
Quezon City, Metro Manila
- 5. Senate Committee on Energy**
GSIS Building, Roxas Boulevard
Pasay City, Metro Manila
- 6. House Committee on Energy**
Batasan Hills
Quezon City, Metro Manila
- 7. Office of the Mayor**
Municipality of Palauig, Zambales
- 8. Office of the Mayor**
Municipality of Iba, Zambales
- 9. Office of the Mayor**
Municipality of Taugtog, Zambales
- 10. Office of the Mayor**
Municipality of Candelaria, Zambales
- 11. Office of the Provincial Governor**
Province of Zambales
- 12. Zambales I Electric Cooperative, Inc. (ZAMECO I)**
Amungan-Palauig-Banlog Road,
San Vicente, Palauig, Zambales
Philippines

