

1. That Applicant SPARC is a corporation duly organized and existing under and by virtue of the laws of the Republic of the Philippines, with principal office at Bonifacio Technology Center, 2nd Avenue corner 31st Street, Bonifacio Global City, Taguig City, Metro Manila. It may be served with pleadings, notices, orders, and other legal processes through the undersigned firm;
2. SPARC is a corporation engaged in the business of generating power derived from solar energy and other viable sources of renewable energy for lighting and power purposes. Copies of relevant documents of SPARC are attached to the Application and made integral parts thereof, to wit:

ANNEX	DOCUMENT
"A"	Certificate of Incorporation
"B"	Articles of Incorporation and By-Laws
"C"	General Information Sheet for Year 2015
"D"	Latest Audited Financial Statement
"E"	Certificate of Non-Coverage Issued by the Department of Environment and Natural Resources (DENR)
"F"	Renewable Energy Developer Certificate Registration issued by the Department of Energy (DOE)

3. As a registered Renewable Energy (RE) Developer, SPARC was granted Solar Energy Service Contract (SESC) to develop, construct, own, and operate a 5 MW solar farm facility on the properties owned by the Agrarian Reform Beneficiaries (ARBs) in Agrarian Reform Communities (ARC) in Barangay Sabang, Morong, Bataan (hereinafter, the "5 MW SPARC Bataan Project");
4. SPARC intends to sell all power generated from its 5 MW PV power plant under the Feed-in Tariff (FIT) System at a rate of PHP 8.69/kWh¹;
5. To fully dispatch the power generated by the 5 MW SPARC Bataan Project, SPARC shall connect to the Peninsula Electric Cooperative, Inc.'s (PENELCO) 13.8 kV primary distribution system through the Morong 5 MVA 69-13.8 substation. The power plant shall be connected to the existing 13.8 kV bus of the

¹ ERC Resolution No. 06, Series of 2015

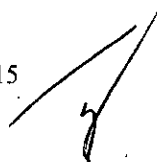

Morong substation as shown by the following single line diagram:

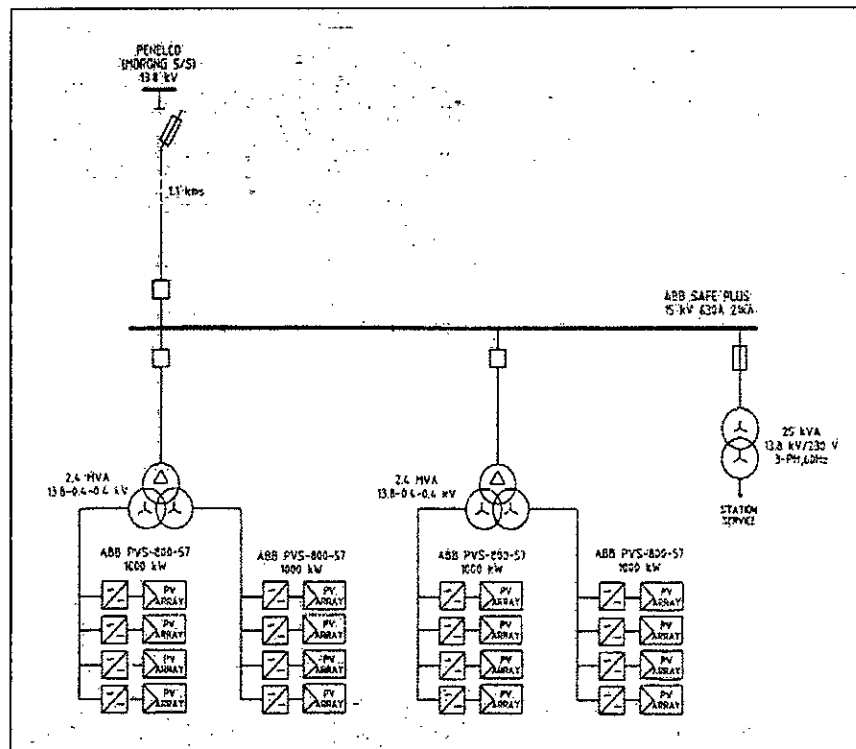

6. The foregoing proposed dedicated point-to-point limited facilities shall be used solely by SPARC to connect its 5 MW SPARC Bataan Project to PENELCO's existing distribution system through the 13.8 kV bus of its Morong substation;
7. The Application was filed to seek the Commission's authorization to develop and own or operate the proposed dedicated point-to-point limited facilities pursuant to *Section 2.9.2 (Connection Assets and Facilities) of the 2010 Distribution Services and Open Access Rules*, as amended (DOSAR), which provides that:

A generation company may develop and own or operate dedicated point-to-point limited facilities provided, that such facilities are required only for the purpose of connecting to the distribution system, and are used solely by the generating facility, subject to prior authorization by the ERC.

8. In deciding that the proposed connection to PENELCO's 13.8 kV primary distribution system through the Morong 5 MVA 69-13.8 kV substation is the most feasible and viable means of dispatching energy from the 5 MW SPARC Bataan Project, SPARC, likewise, considered the option of being directly

connected to the National Grid Corporation of the Philippines (NGCP). However, since the 5MW SPARC Bataan Project is small and can connect to the low voltage lines, it is more economical to be embedded to its host distribution utility than to connect to the high voltage lines of NGCP;

9. Meanwhile, ATEA Inc., a licensed holder of the PSS®E software used to perform the load flow and short-circuit simulations, conducted a Distribution Impact Study (DIS) to determine the feasibility of the proposed dedicated point-to-point limited facilities. A copy of the DIS is attached to the Application as Annex "G";
10. The DIS concluded that the entry of the 5 MW SPARC Bataan Project to PENELCO's distribution system is technically feasible and has the following favorable results: (i) the presence of the 5 MW PV Power Plant in Morong Substation relieves the loading of the existing 5MVA 69-13.9 kV power transformer; (ii) the voltage level improves in the proximate areas; (iii) the short-circuit contribution of the PV plant is small compared with the short-circuit current injected by the Grid;
11. The proposed interconnection facilities partake of an extension of the three-phase primary line of PENELCO's Morong Substation, at a distance of approximately 1.1 kilometers, and using among others, twenty one (21) wooden poles, A7CSR #1/0 and #3/0 AWG 6/1 conductors, 5/16" galvanized ground wires, and 3/8" 7 strand steel guy wires. SPARC shall bear the costs for materials and labor amounting to PhP1,098,279.06. A copy of the Breakdown of Project Cost, including the Design and Staking Sheets, forming an integral part of the application, is attached as Annexes "H" and "H-1".
12. Upon the energization of the facilities, PENELCO shall be responsible for its operation and maintenance in a non-discriminatory manner, such that the availability thereof shall be at the same service level as its distribution system. A Connection Agreement is still being negotiated between PENELCO and SPARC;
13. To fully support SPARC's application for approval of the development, ownership, or operation of the proposed dedicated point-to-point limited facilities, the following documents were submitted:

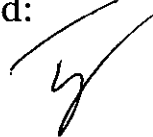

ANNEX	DOCUMENT
"I"	Vicinity Map of the 5 MW SPARC Bataan Project
"J"	Sensitivity Analysis showing Expected Internal Rate of Return
"K"	Single Line Diagram of the 5 MW SPARC Bataan Project
"L"	Gantt Chart/Work Schedule for the proposed dedicated point-to-point limited facilities
"M"	Secretary's Certificate attesting to the resolution of SPARC's Board of Directors authorizing the development and ownership or operation of the proposed dedicated point-to-point limited facilities; the filing of an application with the Commission for authority to undertake the same; designating a representative to said application; and engaging the services of Diccion Law Firm therefor

14. SPARC reserves the right to submit additional documents as may be required by exigencies or when so ordered by the Commission.
15. SPARC intends to qualify and be eligible for the second batch of solar power projects under the FIT System and avail of the FIT at Php8.69/kWh. This new FIT rate for solar will be implemented for new capacities that will be covered by the revised 500 MW installation target, which is valid upon full subscription or until 15 March 2016, whichever comes first²;
16. SPARC is currently in the process of securing permits and undertaking all required activities to be included in the second batch of FIT-eligible solar power projects that can avail of the Php8.69/kWh FIT;
17. However, under the DOE's Department Circular No. 2013-05-0009 governing the selection of RE projects under FIT System and the award of Certificate for FIT Eligibility, to be nominated

² DOE Certification dated 30 April 2014

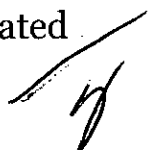

eligible for the second round of solar FIT, SPARC's Electromechanical Completion must first be confirmed by the DOE through the issuance of a confirmation or denial of Electromechanical Completion, including existence of interconnection facility³. It is provided thereunder that:

*Section 6. Issuance of Certificate of Endorsement
for FIT Eligibility.*

- a. *The RE Developer shall inform the DOE that it has attained the Electromechanical Completion of the project to which the latter shall, within fifteen (15) working days from receipt thereof, conduct a site validation and inspection of the project including the interconnection facility.*
- b. *Electromechanical Completion is deemed attained if the construction phase is at least eighty percent (80%) completed as may be determined from the RE Developer's Engineering, Procurement and Construction (EPC) contract or construction and development timeline under the approved Work Plan.*
- c. *Not later than fifteen (15) working days from the last day of site validation, the DOE shall issue the confirmation or denial of the Electromechanical Completion, including the existence of interconnection facility.*
- d. *In the event the DOE confirms Electromechanical Completion of the project, it shall, within a period of five (5) days from the issuance thereof, nominate the eligibility of the project under the FIT system to the Energy Regulatory Commission (ERC) for the processing of Certificate of Compliance (COC) under FIT System, provided that the interconnection facility is fully in place. The DOE nomination to the ERC shall not be constructed as giving right to the RE Developer to be included in the FIT eligible projects.*

18. Strictly applying the foregoing dates, SPARC should notify the DOE that it has attained Electromechanical Completion, including the existence of interconnection facility, not later than 25 January 2016, approximately, excluding the period of

³ Section 6. Issuance of Certificate of Endorsement for FIT Eligibility

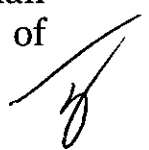

processing with the Commission of a COC under the FIT System. Meanwhile, per its Work Schedule, SPARC undertakes to complete 80% of the construction phase by, more or less, 22 January 2016, when its Electromechanical Completion shall be deemed attained;

19. Thus, prior thereto, it must have already secured authority from the Commission, even on a provisional basis, to develop and own or operate the proposed dedicated point to point limited facilities, and actually construct the same, so it can timely declare Electromechanical Completion;
20. The 5 MW SPARC Bataan Project, therefore, must be immediately connected to PENELCO's distribution system for it to be included within the 500 MW installation target approved for solar energy technology, thereby qualifying it for a FIT for solar approved by the Commission;
21. Pending hearing on the merits, and considering the urgent necessity to beat the foregoing 15 March 2016 deadline, a provisional authority to develop and own or operate the proposed dedicated point-to-point limited facilities to connect the 5 MW SPARC Bataan Project to PENELCO's 13.8 kV primary distribution system through the Morong 5 MVA 69-13.8 kV substation is herein prayed for;
22. Considering that the subject of its Application is analogous to the Commission's approval of electric capital projects, SPARC invoked ERC Resolution No.13, Series of 2006, as amended⁴, insofar as the grant of provisional authority. It is provided thereunder:

ARTICLE II
APPLICATIONS AND REQUIREMENTS

2.3 Evaluation and Approval

- xxx -

Upon filing of the application, the Commission may, on its own or upon motion, grant the issuance of a Provisional Authority (PA) based on the allegations of the application and on such other documents attached thereto or submitted by the parties. The Commission, if necessary, may schedule a hearing for the issuance of a PA not later than thirty (30) days from the

⁴ Resolution No. 18, series of 2008 and Resolution No. 26, Series of 2009

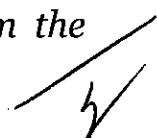

filing of the application. Thereafter, the Commission shall issue a ruling either granting or denying the PA stating clearly the reasons therefore, within seventy five (75) days from the filing of the application.

23. It is imperative for a renewable energy project to be fully connected to the grid or a distribution system and must be able to readily export power to qualify for the FIT. Since the installation target for solar energy resource is only at 500 MW and until 15 March 2016 only, qualifying for FIT is on a first come, first served basis among solar energy projects that are fully commissioned and 100% connected to the grid or the distribution system. As such, any delay on the approval of the proposed interconnection facilities poses additional risks to SPARC in terms of getting its 5 MW SPARC Bataan Project into the 500 MW installation target, that would entitle it to the PhP8.69/kWh FIT rate;
24. Should SPARC fail to be eligible under the second wave of solar FIT, but qualifies only for the next FIT to be determined by the Commission, there is a possibility that the successive FIT for solar will be set at a less competitive rate. It is also uncertain how soon the next solar FIT for the third batch of projects will take effect or be implemented. These uncertainties are perils that SPARC is not willing to take for its 5MW power plant in Bataan, if it were to ascertain the financial viability of the project;
26. In the event that SPARC shall be ineligible for the second round of FIT, its next available option, then, is to deliver power to the Wholesale Electricity Spot Market (WESM). However, considering the unpredictability of market prices, this option will only be detrimental to SPARC in the long run. Further, due to its size and the intermittence of its energy source, SPARC will merely be a price-taker in the WESM. As a price-taker, it will have to settle on whatever price the market dictates, even if such price is not enough to recover costs in ensuring the sustainable and viable operation of its solar energy generation plant;
27. Accordingly, as clearly demanded by the foregoing circumstances, a provisional authority for SPARC to construct and own or operate the proposed interconnection facilities is requested to ensure the viability and sustainability of the 5MW SPARC Bataan Project in Morong, Bataan qualifies for the second round of solar FIT, safeguarding the viability and sustainability thereof.

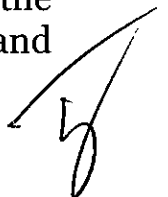

28. SPARC prays that prior to and/or pending hearing on the merits, a PROVISIONAL AUTHORITY be issued to immediately allow the development and ownership or operation of the proposed dedicated point-to-point limited facilities to connect the 5MW SPARC Bataan Project to PENELCO's existing distribution system through its 13.8 kV bus of the Morong substation, and that after due notice and hearing, a FINAL AUTHORITY be issued to permanently authorize the same. Other reliefs as may be just and equitable under the premises are, likewise, prayed for.

Finding the said application to be sufficient in form and in substance with the required fees having been paid, the same is hereby set for determination of compliance with the jurisdictional requirements, expository presentation, pre-trial conference, and presentation of evidence on **11 March 2016 (Friday) at two o'clock in the afternoon (2:00 P.M.) at the ERC Hearing Room, 15th Floor, Pacific Center Building, San Miguel Avenue, Pasig City.**

SPARC is hereby directed to cause the publication of the attached Notice of Public Hearing, at its own expense, once (1x) in a newspaper of general circulation in the Philippines, at least ten (10) days before the date of the scheduled initial hearing. It is also directed to inform the consumers, by any other means available and appropriate, of the filing of the instant application, its reasons therefor, and of the scheduled hearing thereon.

Let copies of the application, this Order, and the attached Notice of Public Hearing be furnished the Office of the Solicitor General (OSG), the Commission on Audit (COA), and the Committees on Energy of both Houses of Congress. They are hereby requested, if they so desire, to send their duly authorized representatives at the scheduled hearing.

Likewise, let copies of this Order and the attached Notice of Public Hearing be furnished the Offices of the Governor of Bataan and the Mayors of the Cities/Municipalities of Bataan (Morong, Mariveles, Cabcaben, Limay, Orion, Pilar, Abucay, Samal, Orani, Hermosa, Dinalupihan, Bagac, and City of Balanga) for the appropriate posting thereof on their respective bulletin boards.

SPARC is hereby directed to furnish all those making requests therefor with copies of the application and its attachments, subject to reimbursement of reasonable photocopying costs.

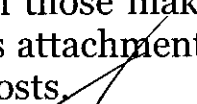

On the date of the initial hearing and pre-trial conference, SPARC must submit to the Commission their written Compliance with the jurisdictional requirements attaching therewith, methodically arranged and duly marked, the evidence of the actual posting and publication of the Notice of Public Hearing consisting of certifications issued to that effect, signed by the afore-mentioned Governors and Mayors or their duly authorized representatives, bearing the seals of their offices, and the affidavits of the Editors or Business Managers of the newspapers where said Notice of Public Hearing were published together with the complete issues of the said newspapers, and such other proofs of compliance with the requirements of the Commission.

SPARC, and all interested parties are directed to submit, at least five (5) days before the date of initial hearing and pre-trial conference, their respective Pre-Trial Briefs containing, among others:

- (a) A summary of admitted facts and proposed stipulation of facts;
- (b) The issues to be tried or resolved;
- (c) The documents or exhibits to be presented, stating the purposes thereof and proposed markings therefore; and
- (d) The number and names of the witnesses, with their written testimonies in an individual affidavit form, to be attached to the Pre-Trial Brief.

Failure of SPARC to submit the required Pre-Trial Brief and Judicial Affidavits of their witnesses within the prescribed period shall be a ground for cancellation of the scheduled hearing, and the resetting of which shall be six (6) months from said date of cancellation.

As part of the pre-trial conference, SPARC must also be prepared to make an expository presentation of their application, aided by whatever communication medium that they may deem appropriate for the purpose, in order to put in plain words and explain, for the benefit of the consumers and other concerned parties, what the application is all about and the reasons and justifications being cited in support thereof.



SO ORDERED.

Pasig City, 10 February 2016.

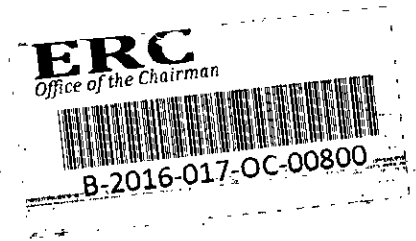

FOR AND BY AUTHORITY
OF THE COMMISSION:

JOSE VICENTE B. SALAZAR
Chairman and CEO

LS: *[Signature]* /apv

Copy furnished:

1. Atty. Mary Ann Castro Diccion-Recto,
Atty. Anna Tricia Paradero Evangelista, and
Atty. Mailyn Pacifico Caspe
Counsels for Applicant SPARC
Diccion Law Firm
Unit 1912 Jollibee Plaza Building
F. Ortigas Jr. Road, Ortigas Center
Pasig City
2. SPARC-Solar Powered Agri-Rural
Communities Corporation (SPARC)
Bonifacio Technology Center,
2nd Avenue corner 31st Street,
Bonifacio Global City,
Taguig City, Metro Manila
3. Office of the Solicitor General
134 Amorsolo Street, Legaspi Village
Makati City, Metro Manila
4. Commission on Audit
Commonwealth Avenue
Quezon City, Metro Manila
5. Senate Committee on Energy
GSIS Building, Roxas Boulevard
Pasay City, Metro Manila
6. House Committee on Energy
Batasan Hills
Quezon City, Metro Manila

7. Office of the Mayor
Municipality of Morong, Bataan

8. Office of the Mayor
Municipality of Mariveles, Bataan

9. Office of the Mayor
Municipality of Cabcaben, Bataan

10. Office of the Mayor
Municipality of Limay, Bataan

11. Office of the Mayor
Municipality of Orion, Bataan

12. Office of the Mayor
Municipality of Pilar, Bataan

13. Office of the Mayor
Municipality of Abucay, Bataan

14. Office of the Mayor
Municipality of Samal, Bataan

15. Office of the Mayor
Municipality of Orani, Bataan

16. Office of the Mayor
Municipality of Hermosa, Bataan

17. Office of the Mayor
Municipality of Dinalupihan, Bataan

18. Office of the Mayor
Municipality of Bagac, Bataan

19. Office of the Mayor
City of Balanga, Bataan

20. Office of the Provincial Governor
Province of Bataan

21. Peninsula Electric Cooperative, Inc. (PENELCO)
Roman Super Hi-Way
Tuyo, Balanga City, Bataan
Philippines